

Hybrid Air & Rubber Cells Layer Tire

Introduction

The Hybrid Air & Rubber Cells Layer Tire is invented with State-of-the-Art and intended to replace the existing tires and work with the existing rims and air pressure sensors to prevent flat tire with the rubber cells layer around the outer layer of the inner tire. The Hybrid Air & Rubber Cells Layer is the layer to protect nails or other sharp objects that may cut the outer part of the tire along the treads; this layer is recommended with at least 2 inches to protect the common nails and would come with different rubber cells patterns. The rubber cells layer would be strong enough to protect the tire even when the tire got a big nail or a cut at lower tire, and this layer would be strong enough without air and would provide great momentum when the wheel is rotating. The inner tire would be air layer like the existing tire, and the process of overlapping rubber sheet for inner tire would be the same as the existing tire. The rubber cells layer would also be overlapped around the inner air tire after overlapping process of the inner tire.

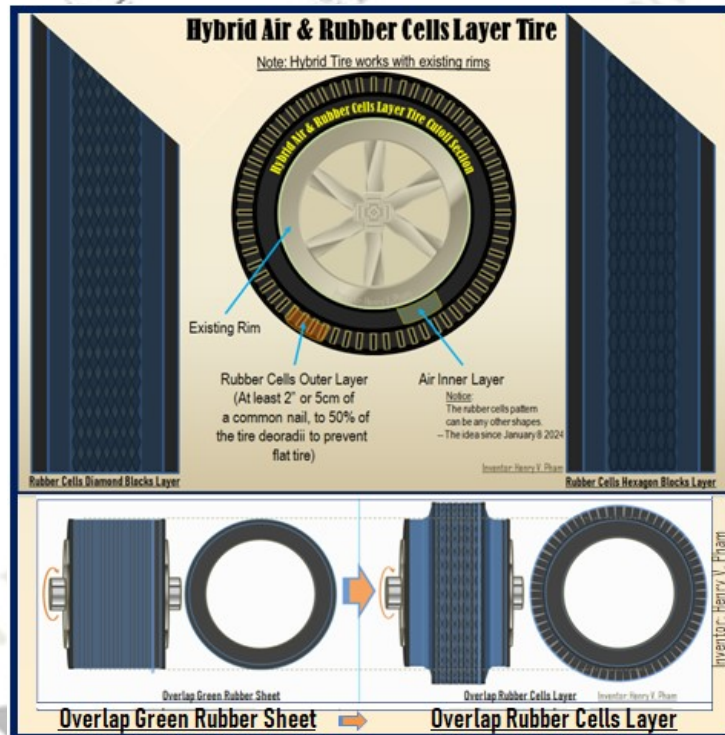

Figure-A: Hybrid Air & Rubber Cells Layer Tire - Overview

Figure above shows the overview of the Hybrid Air & Rubber Cells Layer Tire with the cutoff circle section of the tire with the 2 samples of the rubber cells layer patterns and the overlapping processes of the green rubber sheet for the inner tire (and the outer rubber cells layer before wearing the most outer rubber layer with treading and curing in the mold). The cutoff circle section of the tire shows the 2 main layers, the air inner layer and the rubber cells layer on an existing regular rim sample. While traveling on the road, the car or vehicle got flat tire is dangerous on the road, the Hybrid Air & Rubber Cells Layer Tire or Hybrid Tire in short name is the great promise for future of tires for cars, trucks and even air planes to prevent flat tire and reduce maintenance, and the tire still provides great momentum for the whole wheel with strong support of the rubber cells layer.

Hybrid Air & Rubber Cells Layer Tire

Calculations and Preparations

The Hybrid Air & Rubber Cells Layer is recommended to be at least 2 inches which is the length of the common nail or up to 50% of the tire deoradii of the tire. Note that the deoradii is the delta radii of the outer radius of the tire and the radius of the bead ring of the tire. **Figure-B: Hybrid Air & Rubber Cells Layer – Cutoff Circle Section** shows the cutoff circle section of the Hybrid Tire which is shown on the existing sample rim that works with the existing pressure sensors.

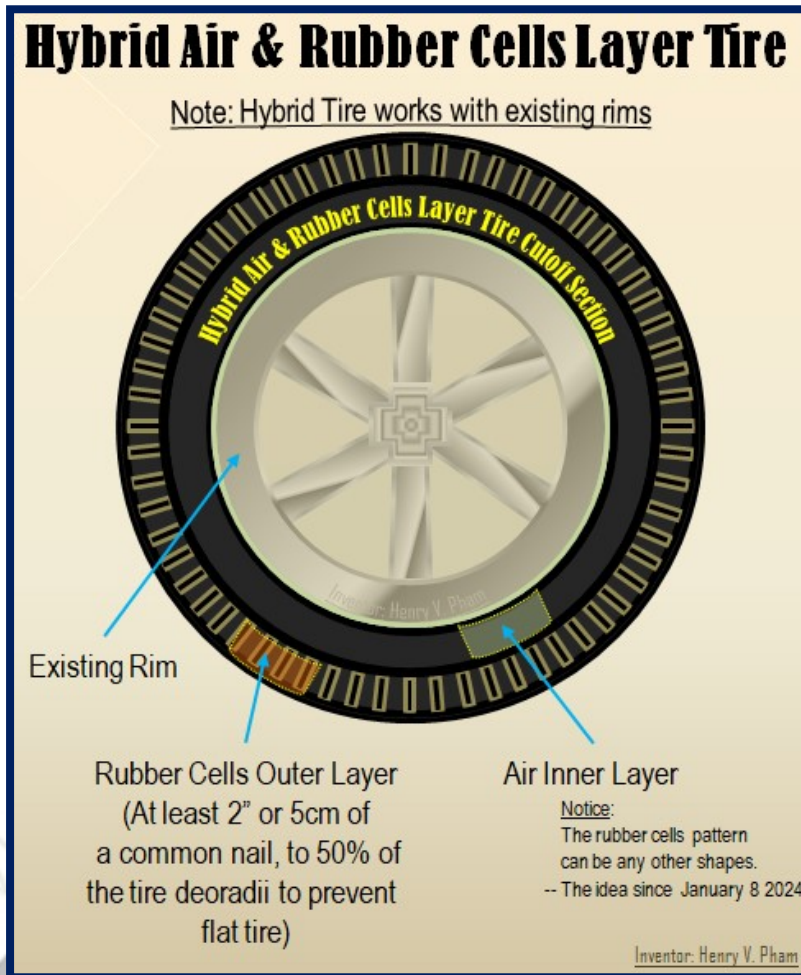

Figure-B: Hybrid Air & Rubber Cells Layer – Cutoff Circle Section

The manufacturers should prepare rubber material with green rubber sheet, and each sheet would be cut in parallelogram shape for better overlapping or similar to the current prepare rubber material process. The green rubber sheet layer would be the base to roll the rubber cells layer right at the center of the rubber sheet. The rubber cells layer is recommended to be pre-molded with rubber cells pattern on top of its own rubber sheet to hold the rubber cells patterns to be a rubber cells layer; the rubber cells top surface is recommended to be molded with fine surface for better bonding during overlapping and curing process; and the rubber cells layer mold is recommended with rubber cells patterns at the bottom and its own rubber sheet on top during rubber cells curing and molding process. The rubber cells patterns would

Hybrid Air & Rubber Cells Layer Tire

Henry V. Pham

be molded in cells layer, and the cells blocks are connected with recommended of ¼ inches and bonded together for stronger support. The rubber cells blocks would be cured and molded to be strong so that the rubber cells blocks can support when the bladder pushing during the final curing process. Note that both inner rubber sheet layer and the rubber cells layer can be impregnated into fabric for strong bonding and supporting. The rubber cells layer would have sidewall along the edge with the recommended thickness about 3/8 to 1/2 inches for regular tire sizes, and larger for bigger tire sizes to support the outer wear rubber layer. **Figure-C: Hybrid Air & Rubber Cells Layer Patterns** shows the inner rubber sheet and the 3 samples of the rubber cells layers, the diamond blocks pattern layer, the hexagon blocks pattern layer and the round blocks pattern layer. Note that the hexagon pattern can be stretched hexagon pattern.

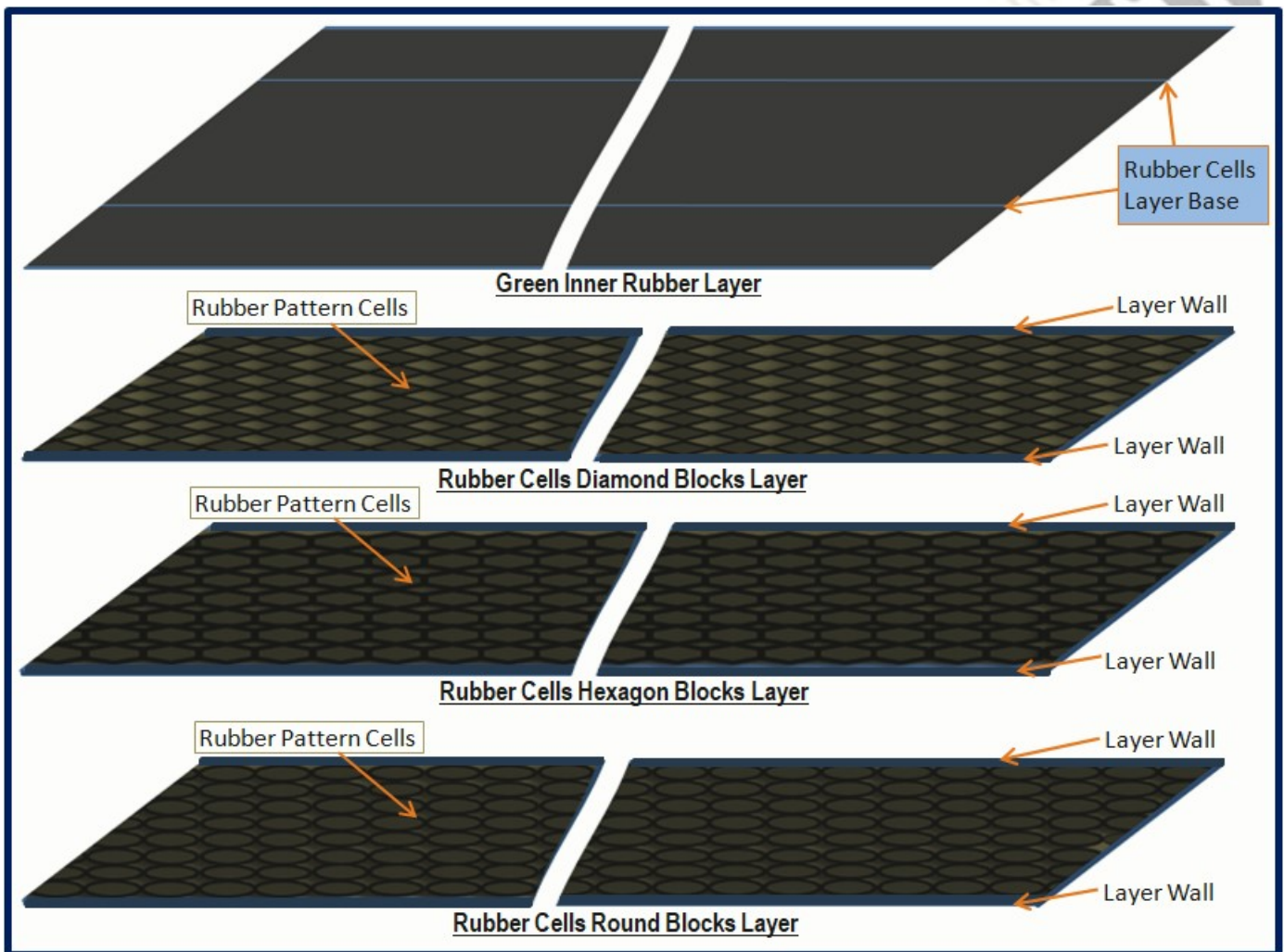

Figure-C: Hybrid Air & Rubber Cells Layer Patterns

The rubber cells layer is thick, and it is recommended to mold with the base rubber layer length shorter than the upper surface length of the rubber cells layer or the layer sidewall; this preparation would help the rubber cells layer wrapping along the inner rubber tire layer for perfect matching the circumferences of the upper and lower rubber cells layer. The rubber cells layer is also recommended to

Hybrid Air & Rubber Cells Layer Tire

Henry V. Pham

mold in parallelogram shape as mentioned above or similar to the precut parallelogram of the green inner rubber sheet of the existing tire manufacture process. **Figure-D: Rubber Cells Layer location on Rubber Sheet Layer - Flat view** shows the rubber cells layer in the flat view of the rubber cells layer place on the rubber sheet when wrapping and overlapping the rubber cells layer on the green rubber sheet. The process of wrapping and overlapping the rubber cells layer on the inner rubber sheet is shown in later sections.

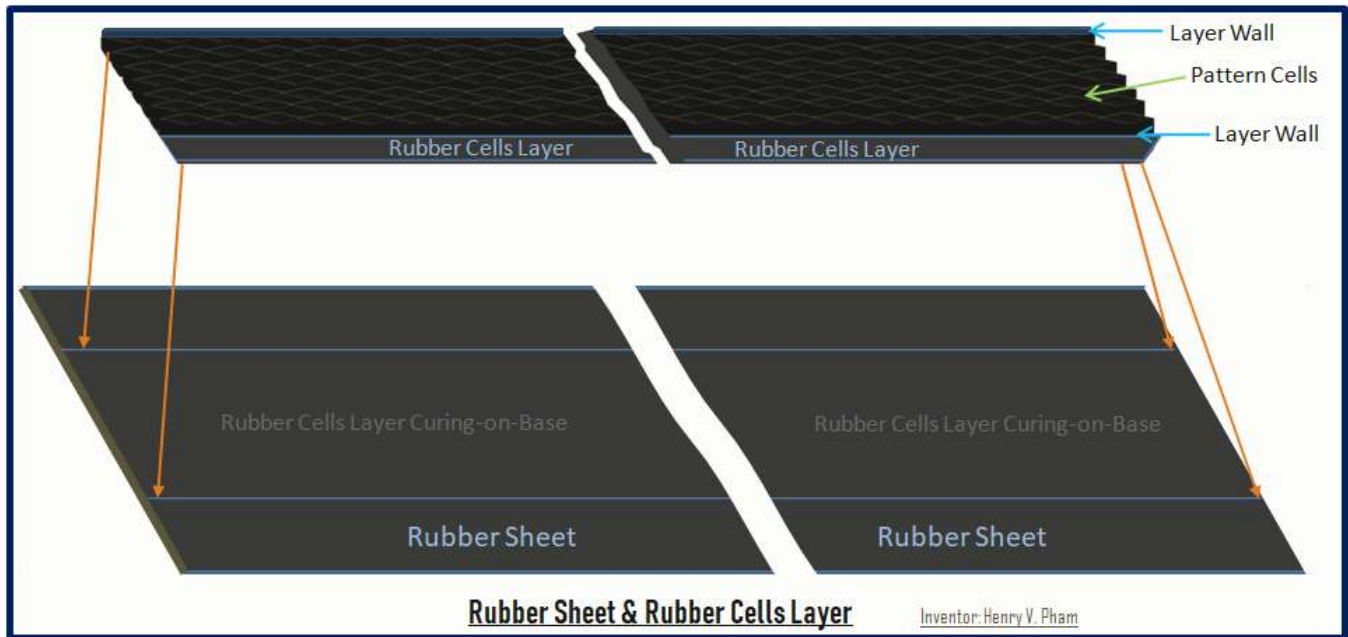

Figure-D: Rubber Cells Layer location on Rubber Sheet Layer - Flat view

To prepare the mold or pre-shape of the rubber cells layer, the thickness 't' of the rubber cells layer must be given and in this case with recommendation of 2 inches to calculate approximate α angle or the folded length 'z' which is magically not related to the radii or the lengths of the circumferences of the upper and lower of the rubber cells layer, which means that the relationship is not related to the tire dimensions; $z = t\pi$; another words, the ratio of folded length 'z' and the thickness 't' is a magic constant PI. Note that the rubber is flexible; the upper circumference can be a bit shorter as the calculated value. **Figure-E: Rubber Cells Layers Deoradii & Circumferences Calculations** shows the sample calculation of the ratio above. Where 't' is the thickness or the deoradii of the rubber cells layer, C_R is the circumference of the outer or upper circle, C_r is the circumference of the inner or lower circle. We have, $C_R = 2R\pi$; and $C_r = 2r\pi$; then,

$$C_R - C_r = 2R\pi - 2r\pi = 2\pi(R-r)$$

$$\text{Let } R = t + r; \text{ and } (C_R - C_r) = 2z$$

$$2\pi(t + r - r) = 2z;$$

$$\text{Then, } z = t\pi$$

Hybrid Air & Rubber Cells Layer Tire

Henry V. Pham

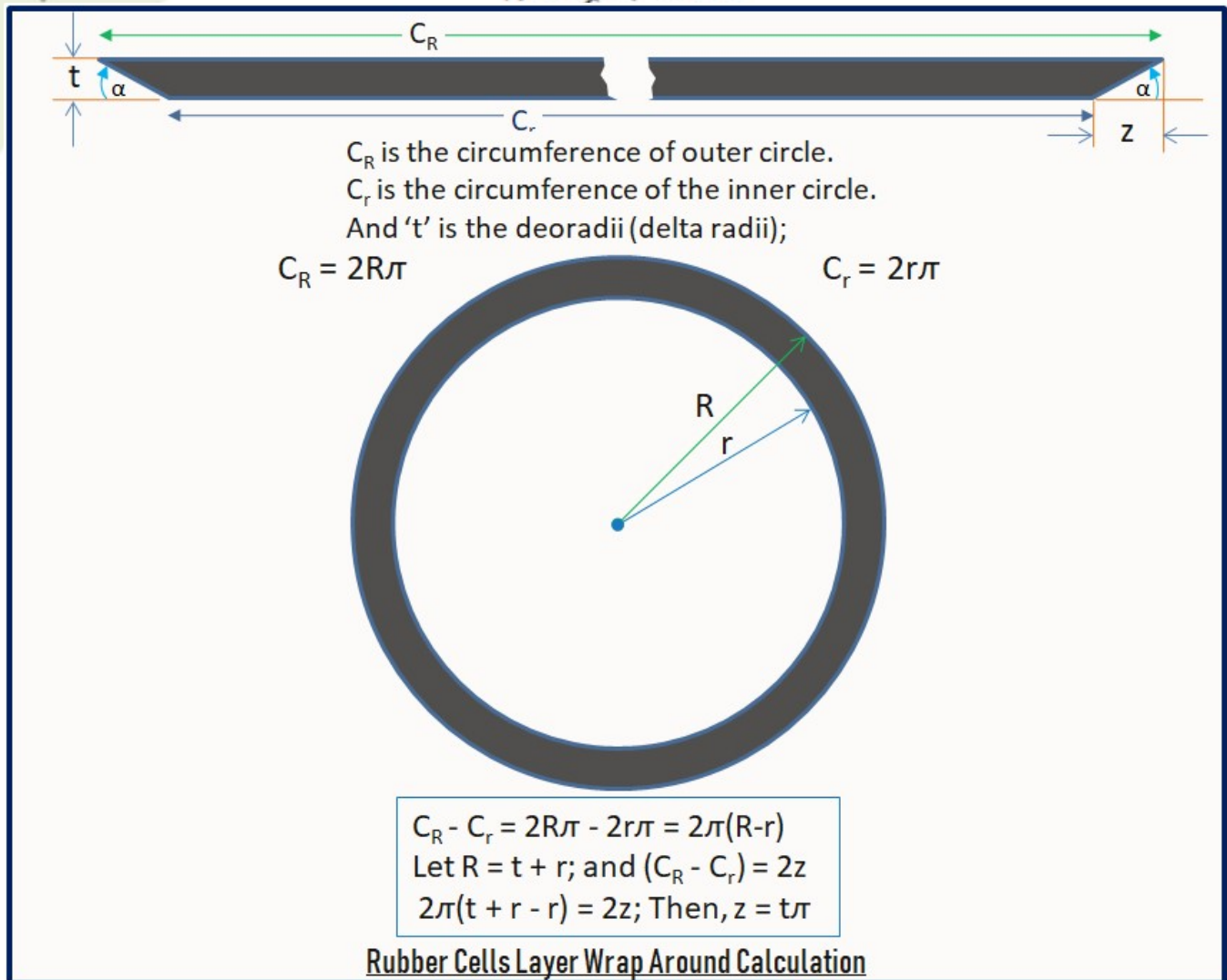

Figure-E: Rubber Cells Layers Deoradii & Circumferences Calculations

Inner Layer & Rubber Cells Layer Overlapping Processes

Similar to the existing tire processes, the Hybrid Air & Rubber Cells Layer tire is introduced with an extra step of tire process to wrap or overlap the rubber cells layer on the green inner rubber layer after overlapping the green inner rubber sheet layer as the inner rubber tire of the existing tire process. The green inner rubber sheet in parallelogram shape is wrapped and overlapped to make an inner rubber tire which is used for air region of the tire. This air region of the tire is smaller in diameter compare to the existing tire to yield the outer region for the rubber cells layer which is recommended with 2 inches for common regular tire sizes. Similar to the green inner rubber sheet layer overlapping process, the rubber cells layer is wrapped and overlapped on the green inner rubber layer after the green inner rubber layer overlapping process which is shown in [Figure-F: Hybrid Air & Rubber Cells Overlap Inner Layers Processes](#). The rubber wrapper or wrapper strips for both green rubber sheet layer and rubber cells layer is recommended to be thick enough to provide strong bonding between layers after the curing process.

Hybrid Air & Rubber Cells Layer Tire

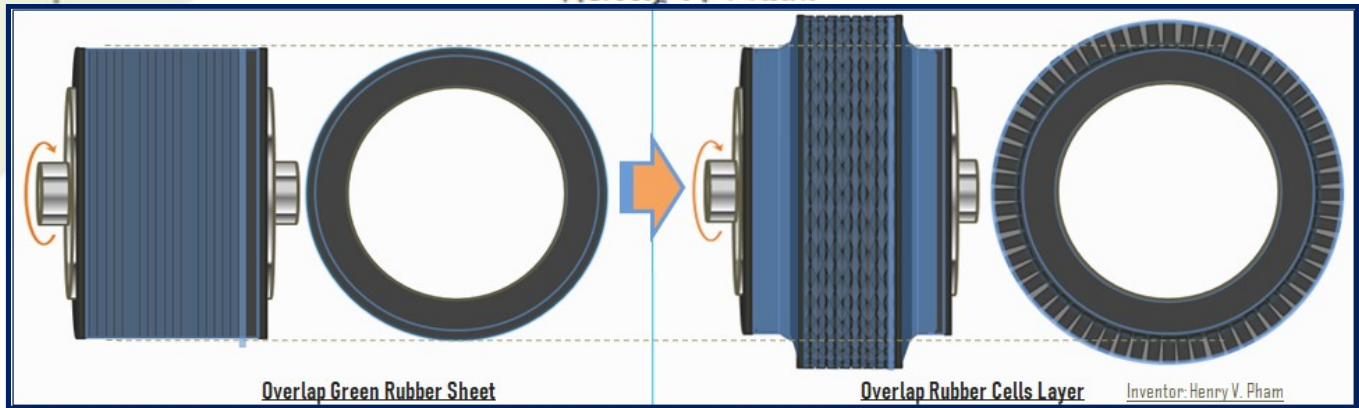

Figure-F: Hybrid Air & Rubber Cells Overlap Inner Layers Processes

The process of overlapping green inner rubber sheet to form an inner rubber tire layer is similar to the existing tire process except this layer has smaller diameter compare to the existing tires. **Figure-G: Rubber Sheet Rolling & Overlapping Inner Layers Processes** shows more detail about wrapping and overlapping inner rubber layer. The rubber sheet in parallelogram shape after overlapping to connect both sides like a cylinder as shown with radius R_{rs} would go through a mechanism to push the center region out to form like an inner tire; the top drawings show the process of wrapping, overlapping and making an inner rubber tire. The existing mechanism of the current standard tire manufacture for this process would be similar except for the pushing center region out of the rubber sheet to a smaller diameter which is smaller air region compare to the existing tire. The rubber sheet thickness is recommended to be similar to the existing tires; after wrapping and overlapping the inner rubber sheet layer, the inner tire would have outer radius R''_{rs} and inner radius R'_{rs} where the bead resides with similar bead ring radius.

After process of the **inner rubber air tire** above, the next step is the most important one to wrap and overlap the rubber cells layer so that the rubber cells layer stays strong and bonds better on the outer surface of the inner rubber air tire from the above process. **Figure-H: Rubber Cells Layer Rolled on Rubber Sheet Inner Tire with Overlapping Process** shows more details of the rubber cells layer wrapping and overlapping process. Based on the same mechanical from the above process, the pre-cut or pre-molded rubber cells layer is now can be wrapped around the inner rubber air tire with recommendation of applying rubber glue or rubber adhesive on top of the inner rubber tire to help make the rubber cells layer bonding right on the inner rubber air tire before overlapping on top of the rubber cells layer. Because the rubber cells layer is already cured and pre-molded for strong support during the final curing process with high temperature, the rubber cells layer is recommended to wrap with a strong thin fabric rubber sheet on top of the rubber cells layer with rubber adhesive with additional recommendation of adhesive foam padding into the cells holes before overlapping on top after the rubber cells layer is wrapped around the inner rubber air tire to prevent the green rubber from the outer wear rubber pushing inward during the final curing process. Note that the padding foam material into the rubber cells holes can be Neoprene foam, Poly Ethylene Vinyl Acetate foam or similar with medium or high density, lightweight and durable so that the foam can stay in shape with high PSI pressure and temperature during final curing process. The rubber cells layer overlapping process can be proceed right after applying the fabric rubber sheet on the rubber cells layer

Hybrid Air & Rubber Cells Layer Tire

Henry V. Pham

with padding foams; the overlap rubber strips or bands would be cured and bonded within the rubber layers. The lower drawings in **Figure-H** show the overlapping process of the rubber cells layer, and the dimension of the processing tire are now expected to be similar to the existing tire process from the manufactures without the outer wear rubber layer for treading.

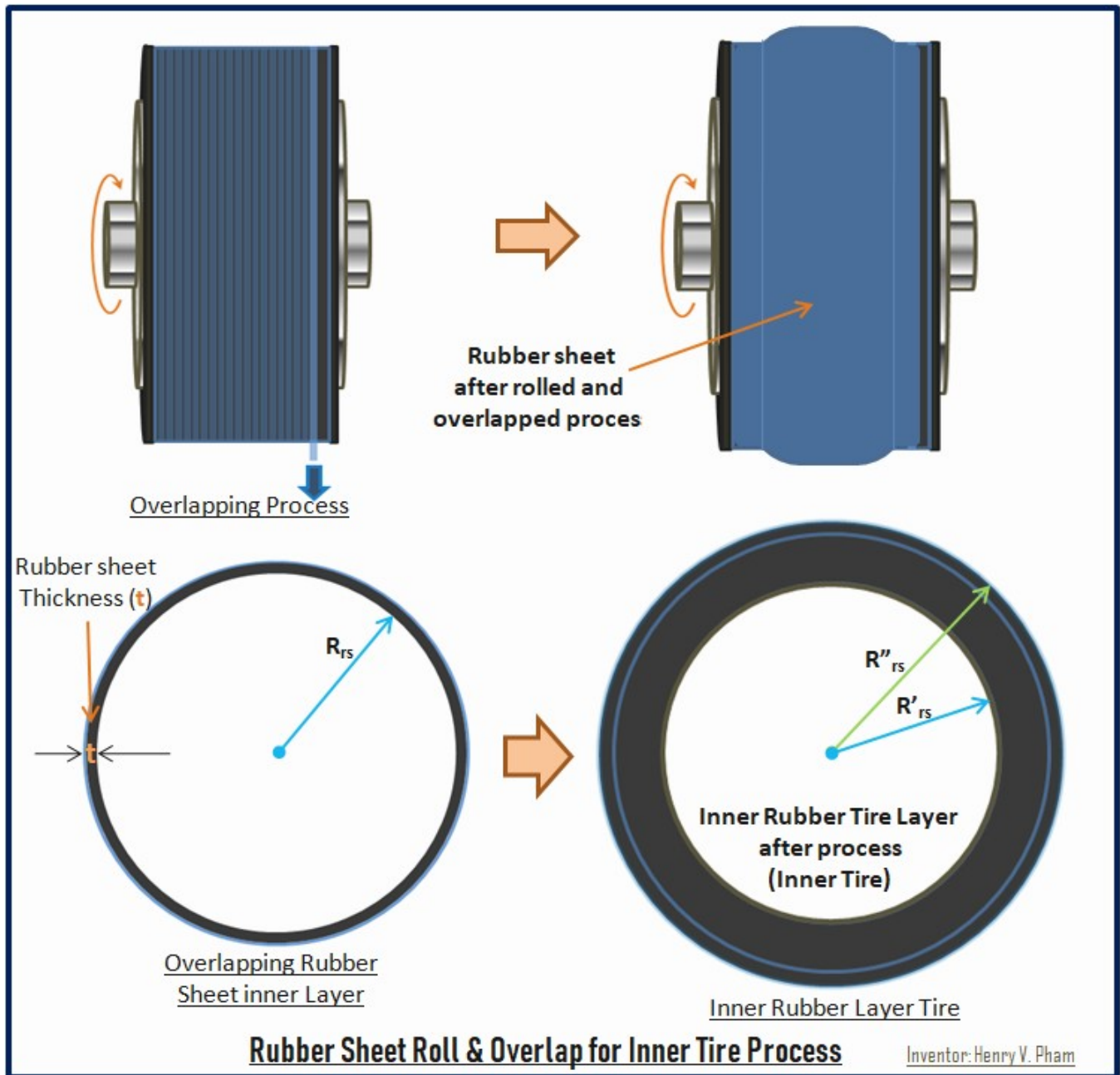

Figure-G: Rubber Sheet Rolling & Overlapping Inner Layers Processes

After the above processes, the beads for both sides of the tire can be installed which is expected to be the same as the current tire standard processes from the manufactures. The outer wear rubber

Hybrid Air & Rubber Cells Layer Tire

Henry V. Pham

layer which is used for treading can also be wrapped and overlapping around the processing tire from the above steps which is expected to be the same as the current tire processes from the manufactures.

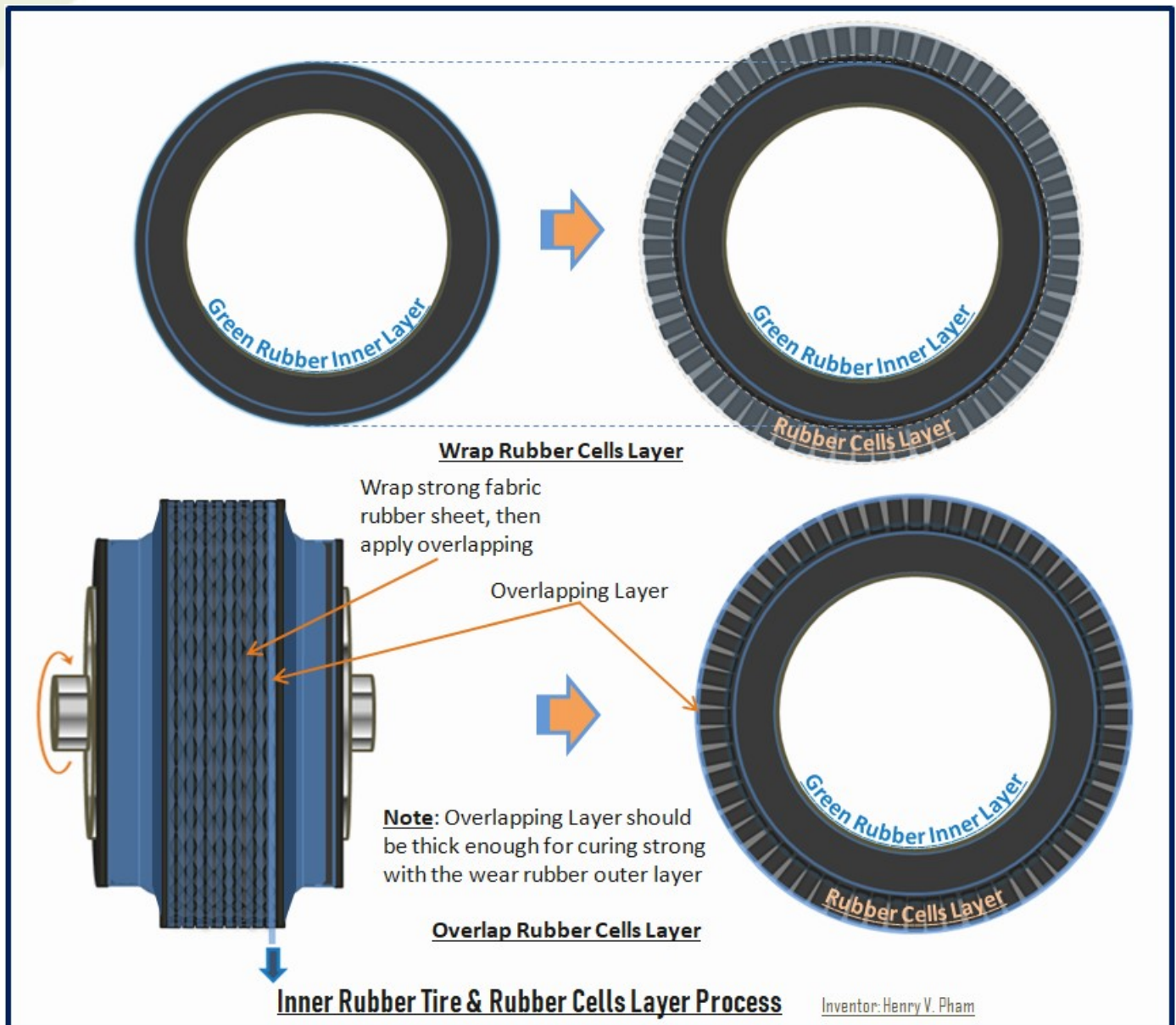

Figure-H: Rubber Cells Layer Rolled on Rubber Sheet Inner Tire with Overlapping Process

Note that the new rubber cells layer introduced in this invention is pre-molded with sidewalls which are used to prevent the green rubber get into the cells; the process of wrapping and overlapping outer wear rubber layer also should be ensure thick enough to cover the rubber cells layer sidewalls for perfect tire shape and for better rubber bonding with inner layers during the final curing process with high temperature based on the tire standard processes. The process of wrapping and overlapping the outer wear rubber layer which is used for treading is expected to be the same as the current tire manufacturing processes; and the processing tire is now should be ready to put in the mold for final curing process and ready for production.

Hybrid Air & Rubber Cells Layer Tire Molding & Curing Processes

When the tire is completely wrapped and overlapped all the layers together, the tire is ready to put into the mold for curing process. The tire mold for Hybrid Air & Rubber Cells Layer tire would be the same as the standard manufacturing tire molds with different sizes. Figure-I: Hybrid Air & Rubber Cells Layer Tire Base Mold Sample shows a sample mold base with sidewalls which would be used to imprint the tire dimension and tire info of the manufacturer. The mold would have treads mold around with the sidewall molds, and the mold would have the open center to insert the air bladder which is used to push the rubber layers to mold walls while the hot air get filled into the bladder for final curing process; note that treads directions are also important, and this is the standard requirement, but the tire treads may come with different patterns depends on the manufactures. And the tire mold would have different tire marks to identify the inside and outside of the tire as standard procedure from the manufactures. The mold could be divided by 2 parts, top and bottom and recommended with 4 or more sectors, or with existing methods which are used to open the mold to remove the finish cured tire easier; different manufacturers may have different mold opening options to remove the tire. Note that there are over 100 tire manufacturers around the world today with more than 100 years of tire manufacturing since World War I or even earlier.

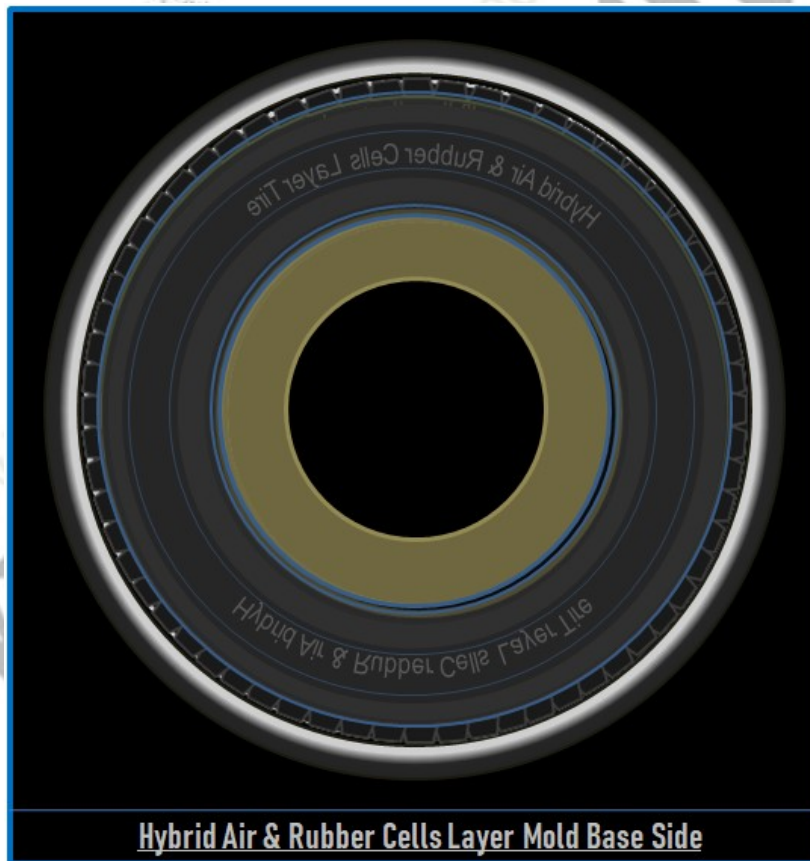

Figure-I: Hybrid Air & Rubber Cells Layer Tire Base Mold Sample

The below Figure-J: Hybrid Tire with Outer Wear Rubber Layer in Semi-Transparent Mold shows the Hybrid Air & Rubber Cells Layer Tire in a semi-transparent mold without top mold cover to provide the viewable rubber

Hybrid Air & Rubber Cells Layer Tire

tire layers regions. The inner rubber tire region is shown inside the rubber cells layer region, and the outer wear tread rubber layer region is outside of the rubber cells layer region. The entire tire with beads and wrapped and overlapped layers is fit into the tire curing mold and ready for the final curing process.

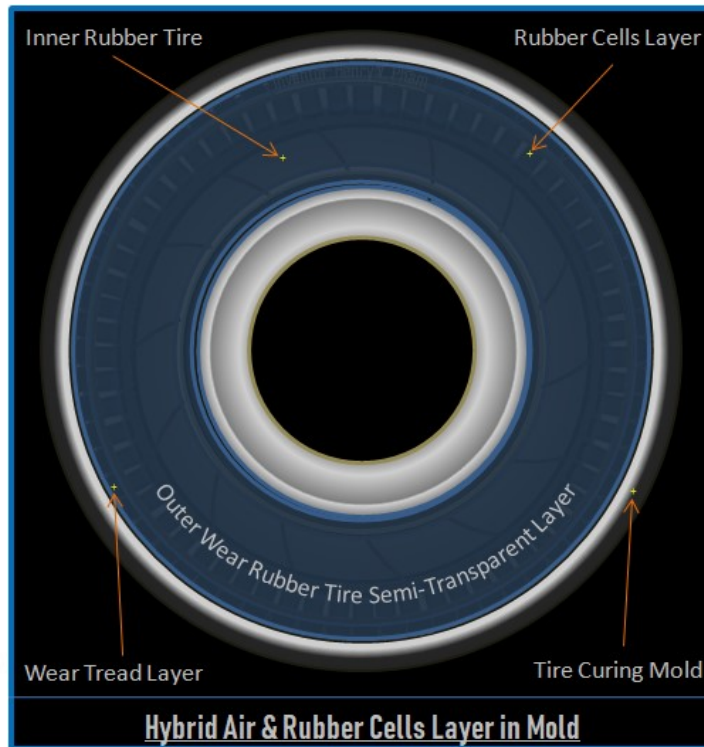

Figure-J: Hybrid Tire with Outer Wear Rubber Layer in Semi-Transparent Mold

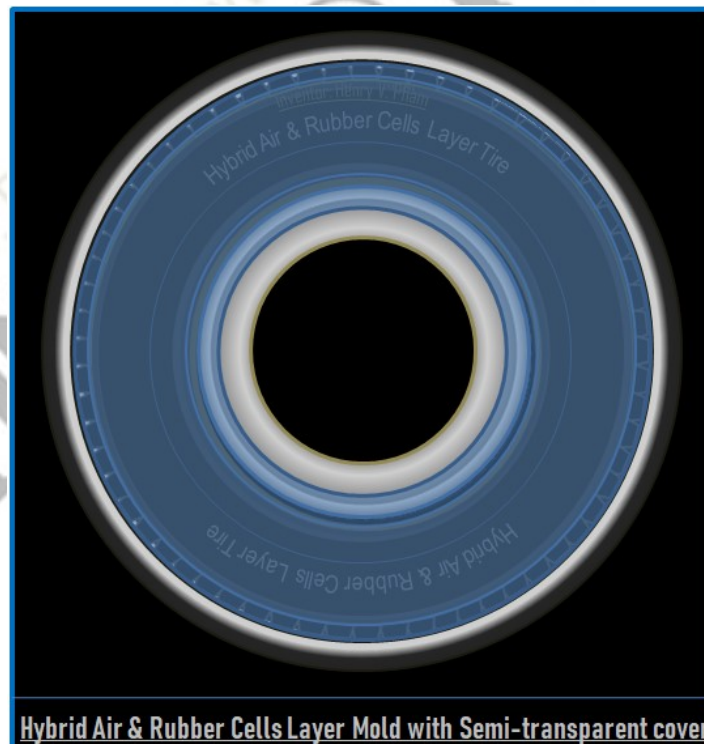

Figure-K: Hybrid Tire with Semi-Transparent Top Cover Mold

Hybrid Air & Rubber Cells Layer Tire

Similar to the existing tire manufacturing molds, the top cover mold would have the tire and manufacturer info on the sidewall. **Figure-K: Hybrid Tire with Semi-Transparent Top Cover Mold** shows the tire is put into the mold with the top cover mold in semi-transparent view.

When the tire is ready into the mold, the mechanical of the molding processes insert the air bladder into the center of the mold like the existing manufacturing process and apply heat with standard high temperature that requires for curing the tire. Since the Hybrid tire only have extra rubber cells layer which already molded with strong fabric rubber cells and padded cells holes with foams to support during curing process with glued or adhesive wrapper layers that help rubber cells layer bonding with other rubber layers, so the temperature that requires for final curing process of the tire would be similar to the current tire manufacturing. **Figure-L: Hybrid Tire with Semi-Transparent Mold in Curing Process** shows the intake hot air bladder insert into the mold within tire inner diameter, and the bladder will expand bigger when the top and bottom bladder tied up on to the mold with more intake air to push the inner tire layers out to the edge around the mold with high enough temperature and pressure to make all the layers bonding strong with tire treads along the mold for the final curing process. Note that the curing standard temperature could be up to 350° Fahrenheit with the pressure up to 350 PSI for about 15 minutes. This figure shows the layer regions when the tire is in curing process in a mold; hot air bladder is shown in orange region, rubber cells layer is shown in dark yellow region, and the outer wear rubber layer is shown in blue with mold treads. Note that the tire with all layers that are wrapped and overlapped is put into the mold with upper tire mold and lower tire mold as shown in this figure.

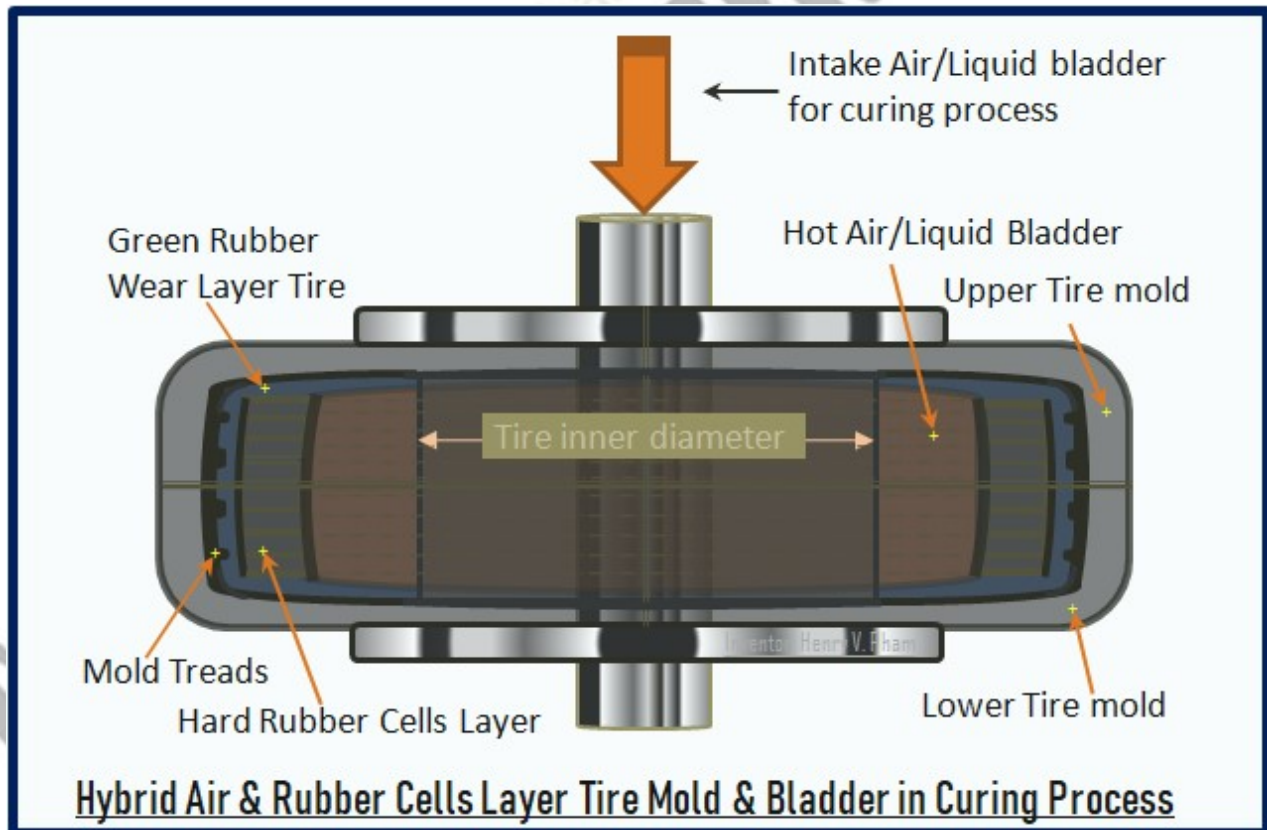

Figure-L: Hybrid Tire with Semi-Transparent Mold in Curing Process

Hybrid Air & Rubber Cells Layer Tire

After the tire is completely cured and molded for about 15 minutes as current standard curing processes and depends on the tire dimensions, the air bladder is released from the mold and the mold can be opened to remove the finish tire for production. **Figure-M: Hybrid Tire with Semi-Transparent Mold after Curing Process** shows the bladder is released from the mold and the tire is cured and ready to remove from the mold with cooler temperature after curing process which shows blue color for entire mold instead of hot orange color. The final tire production sample will be shown in next section in this invention document. Note that the curing and molding processes would be the same with the current tire manufacturing processes since the Hybrid Air & Rubber Cells Layer tire dimensions or shapes would be the same as the desired tire dimensions as mentioned earlier.



Figure-M: Hybrid Tire with Semi-Transparent Mold after Curing Process

Hybrid Air & Rubber Cells Layer Tire

Hybrid Tire Production

After the final curing process completed, the Hybrid Air & Rubber Cells Layer Tire would look similar like the existing standard tire in dimensions and the shapes that would fit with existing rims of the wheels with the same desired dimensions; this means that the users can replace the old tires with the Hybrid tires for their existing cars. Figure-N: Hybrid Air & Rubber Cells Layer Tire after molding shows a Hybrid tire sample in production after completion of final tire processes and ready for use.



Figure-N: Hybrid Air & Rubber Cells Layer Tire after molding

The Hybrid Air & Rubber Cells Layer Tire components are similar to the existing tire with extra rubber cells layer which is the main layer introduced in this invention to prevent flat tire for existing cars, trucks and air planes. The outer wear rubber layer was cured in the mold in high temperature with high pressure of the air bladder to produce the treads of the tire with both sidewalls bonding into the inner rubber layers like the existing tires. The belts or belt wedge layers are the composited nylon ply layers of fabric rubber layer similar to the layer right under the tire treads layers of the existing tires which protect the rubber cells layer for the Hybrid tire. This protection layer is similar to the layer under the rubber cells layer which is mentioned above that built similar to the existing inner protection layer tires. Figure-O: Hybrid Air & Rubber Cells Layer Tire Inner Sections View shows the inner components of a sample Hybrid tire.

Hybrid Air & Rubber Cells Layer Tire

Henry V. Pham

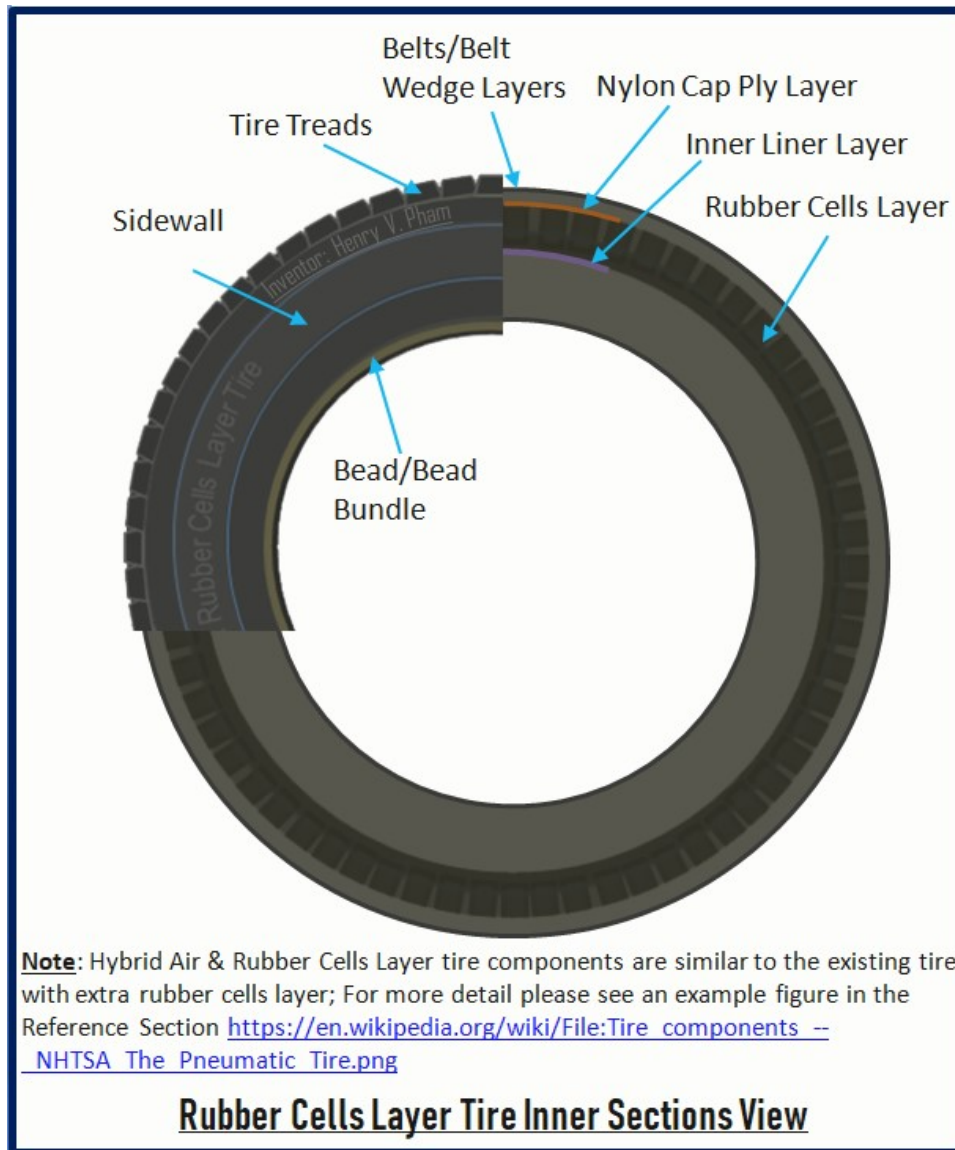

Figure-0: Hybrid Air & Rubber Cells Layer Tire Inner Sections View

Summary

The Hybrid Air & Rubber Cells Layer Tire or Hybrid Tire in short name is invented with State-of-the-Art and intended to replace the existing tires, and it should work with the existing rims and air pressure sensors to prevent flat tire with the rubber cells layer around the outer layer of the inner air tire. The Hybrid Air & Rubber Cells Layer is the layer to protect nails or other sharp objects that may cut the outer part of the tire along the treads; this layer is recommended with at least 2 inches to protect the common nails and would come with different rubber cells patterns. With additional option of padding foam into the rubber cells holes which can be used material such as Neoprene foam pads or similar with medium to high density, lightweight and durable, the foam can stay in shape with high PSI pressure and temperature

Hybrid Air & Rubber Cells Layer Tire

during the final curing process. The rubber cells layer would be strong enough to protect the tire even when the tire got a big nail or a hole at the lower tire, and this layer would be strong enough without air and would provide great momentum when the wheel is rotating. The inner tire would be air tire layer like the existing tire, and the process of overlapping rubber sheet for inner tire would be the same as the existing tire of the standard manufacturing processes. The rubber cells layer would be also overlapping around the inner air tire after the overlapping process of the inner tire. The Hybrid Air & Rubber Cells Layer Tire or Hybrid Tire in short name is the great promise for future of tire manufacturing for cars, trucks and even air planes to prevent flat tire and reduce maintenance while the tire can provide great momentum for the whole wheel with strong support of the rubber cells layer.

References

1. [https://en.wikipedia.org/wiki/File:Tire_components -- NHTSA The Pneumatic Tire.png](https://en.wikipedia.org/wiki/File:Tire_components_-_NHTSA_The_Pneumatic_Tire.png) shows the existing tire layers and components in wiki which has been posted publicly as shown in **Figure-R1: Existing Tire Inner Layers Sections Reference** for references.

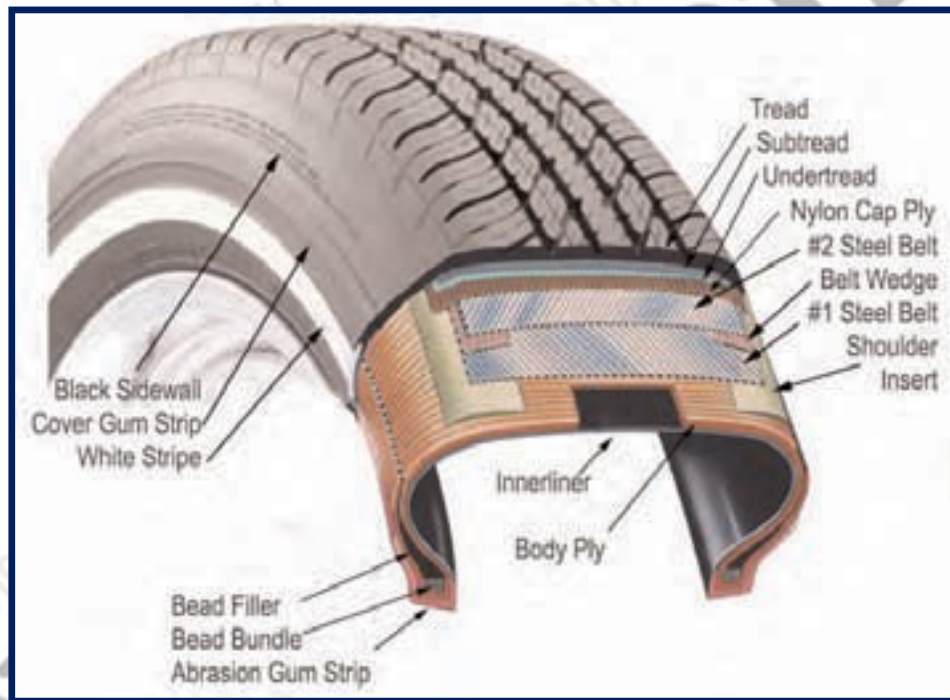

Figure-R1: Existing Tire Inner Layers Sections Reference

2. https://en.wikipedia.org/wiki/Tire_manufacturing shows the existing tire cuing process which has been posted publicly in wiki as shown in **Figure-R2: Existing Tire with Old Production Reference** and **Figure-R3: Existing Tire with Mold & Bladder Reference** for references.

Hybrid Air & Rubber Cells Layer Tire



Production of tires in France, ca. 1950s

Figure-R2: Existing Tire with Old Production Reference



An opened tire mold being cleaned. The deflated rubber bladder is on the central post.

Figure-R3: Existing Tire with Mold & Bladder Reference

Hybrid Air & Rubber Cells Layer Tire

Biography



About myself, my full name is Henry Viet Pham, original name was 'Viet Hong Pham', changed in 1996 when obtained U.S. citizenship, and currently live in Anaheim, California. I am a father of 3 sons, Alexander Le Pham, Andrew Le Pham, and Harry Quoc Pham and my wife Celine Nguyet Tran. I was born in Vietnam at Dang Nang city in 1972/08/23 then moved to my grandfather's hometown with the family right after the South Vietnam collapsed in 1975 and grown up at Binh My, Binh Son, Quang Ngai. When I was 9 years old in fifth grade in 1981, the local school requested to adjust birth date year to 1971 to match education age; my father used the original Birth Certification before 1975 for the HO program paperwork for immigration. Then, I came to United States in 1991 as a military and political immigrant with my father and family members. My father Nu Pham who served as a Lieutenant in military during Vietnam War in 1975, and my mother is Thong Thi Tran with my sisters are Nguyet Thi Pham, Jessie Nga Pham and Tiffany Tuyen Pham, and my brothers are Duc Hong Pham, Kevin Tri Pham, Danny Phuc Pham, and Andy Quy Pham.

About Education, I came to United States after finished my high school at TPTH Binh Son in 1989 at Quang Ngai, Vietnam; and I continued my education right after came to U.S. and I got my Bachelor Degree in Electrical and Computer Engineering at Calpoly Pomona, California in 1998. I am interested in Engineering and Science, and I have done many researches and self-study since I graduated in 1998 and continue researching and inventing with total of 15 inventions which have been submitted for patents from June 2021 to November 2024, and I still have many other inventions to work on and open the Cloud OS Company for business.

Hybrid Air & Rubber Cells Layer Tire

Henry V. Pham

About my works and inventions, I have over 25 years of professional experience in high technology industry since 1998. I have worked for Eden Airport Ground Service Company in Los Angeles Airport in 1995; worked for Caltrans in 1997; worked for Raytheon, a defense company from year 1998 to 2005; worked for Marshal 8e6, an internet security company from year 2006 to 2010; worked for Pace America, a Satellite Set Top Box in 2010; and worked for Western Digital, a storage technology company, from year 2010 to 2024. I am a sole inventor of a total of 15 inventions which have been submitted from June 2021 to November 2024 as followings.

1. Invention Title: New Way to protect WiFi Network from Hackers – Submission with U.S. Patent PCT No.: 29/788,607; Submitted on: 2021/07/01; and resubmitted on 2024/02/27 to WIPO international office with U.S. Patent PCT No.: PCT/US24/17533 and International Patent: PCT/IB2024/000110;
2. Invention Title: THE G-CODE – First submission with U.S. Patent PCT No.: 29/806,573 => then resubmitted with PCT/US22/70704; and International Patent: PCT/IB2022/000112; Submitted on: 2021/09/03;
3. Invention Title: The Cloud OS - Operating System – Submission with U.S. Patent PCT No.: PCT/US21/71689; and International Patent: PCT/IB2021/000683; Submitted on: 2021/10/02;
4. Invention Title: The LPS - Local Positioning System – Submission with U.S. Patent PCT No.: PCT/US21/72562; and International Patent: PCT/IB2021/000949; Submitted on: 2021/11/23;
5. Invention Title: Greatest Performance Hard Drive (G-Drive) – Submission with U.S. Patent PCT No.: PCT/US21/72563; and International Patent: PCT/IB2021/000961; Submitted on: 2021/11/23;
6. Invention Title: Cell eMap Live Updates System – Submission with U.S. Patent PCT No.: PCT/US22/79368; and International Patent: PCT/IB2022/000685; Submitted on: 2022/11/07;
7. Invention Title: LPS Navigation System – Submission with U.S. Patent PCT No.: PCT/US22/79369; and International Patent: PCT/IB2022/000671; Submitted on: 2022/11/07;
8. Invention Title: Emergency Traffic Lights Routing System – Submission with U.S. Patent PCT No.: PCT/US22/82343; and International Patent: PCT/IB2022/000791; Submitted on: 2022/12/23;
9. Invention Title: G-ROUTING ALGORITHM METHODOLOGY -- Submission with U.S. Patent PCT No.: PCT/US22/82347; and International Patent: PCT/IB2022/000800; Submitted on: 2022/12/23;
10. Invention Title: Parallel Transforming Percentage Theorem -- Submission with U.S. Patent PCT No.: PCT/US23/77057; and International Patent: PCT/IB2023/000611; Submitted on 2023/10/23;
11. Invention Title: Auto Following Motion Security Camera -- Submission with U.S. Patent PCT No.: PCT/US24/13660; and International Patent: PCT/IB2024/000177; Submitted on: 2024/01/31;
12. Invention Title: Wall Security Camera System -- Submission with U.S. Patent PCT No.: PCT/US24/13663; and International Patent: PCT/IB2024/000096; Submitted on: 2024/01/31;
13. Invention Title: OH SMART AIRPORT -- Submission with U.S. Patent PCT No.: PCT/US24/43532; and International Patent: PCT/IB2024/000451; Submitted on: 2024/08/23;

Hybrid Air & Rubber Cells Layer Tire

14. Invention Title: Touch Slide & Landing Board for Aircraft Carrier -- Submission with U.S. Patent PCT No.: PCT/US24/52509; and International Patent: PCT/IB2024/000586; Submitted on: 2024/10/23;

15. Invention Title: Cybercopter Flyer -- Submission with U.S. Patent PCT No.: PCT/US24/52515; and International Patent Number is still waiting for WIPO assigned a Patent Number -- Submitted on: 2024/10/23;

This invention, "Hybrid Air & Rubber Cells Layer Tire" is intended to submit on 2024/12/23, and my other inventions are listed as followings, "Emergency Cylinder Helical Stair" which is used in OH SMART AIRPORT and for commercial use for personal and emergency purposes, "Personal One Step Escalator" which is intended to provide personal use like elevator in compact space, "Smart Cart Gear Belt System" which is used in OH SMART AIRPORT and intended to use for commercial for Smart Cart Exchanger, "Transpond License Plate" which is intended to use for tracking license plate within a desired distance, "Auto Tracking Target Network Security Cameras System" which is intended to use in the crowd areas like airport to follow and track the suspect/target for crowd security camera system, "Robot Medical Doctor" which is intended to help family doctors and hospital to check up patients faster with better medical statistic data with built-in Machine Intelligence (MI), and direct business related inventions, "Matrix Base Keyboard" to prevent wire/wireless keystrokes logger and "One Round Chamber" for data storage hard drive (one of my invention 'Greatest Performance Hard Drive') tester.

About my business, the Cloud OS Company with website www.TheCloudOSCenter.com business uses mainly Invention #3: The Cloud OS – Operating System, Invention #5: Greatest Performance Hard Drive (G-Drive), and Invention #9: G-ROUTING ALGORITHM METHODOLOGY. The Cloud OS Company business brings the world to the next level of World Computing Infrastructure Modern with the main purposes to secure users' data and secure entire computer networking around the world or the World eWeb with the new technology of Neighbor-to-neighbor checking methodology and Neighbor-to-neighbor routing technology, and applying the new dynamic protocol technology for data transferring with the high secure of the 4K Number Encryption. And there are my other 3 businesses related websites www.TheGCODECreator.com which is used for the G-CODE labels/profiles/products/logos creator application; www.ThePatrolCircle.com which is used to patrol the points of interests for security camera system with Patrol Circle Unmanned Aircraft; and www.TheCybercopterFlyer.com which is used for Cybercopter Flyer, the Cybercopter flyer is intended to replace the current helicopters and for future of aviation transportation in circle shape like UFO flyers which can support both turbofan and turbojet engines with cell fuel and solar energy.